



Smart Interactive Whiteboard

Quick Start Guide







Foreword

General

This manual introduces the functions and operations of the smart interactive whiteboard (hereinafter referred to as "the whiteboard"). Read carefully before using the whiteboard, and keep the manual safe for future reference.

Safety Instructions

The following signal words might appear in the manual.

Signal Words	Meaning
 DANGER	Indicates a high potential hazard which, if not avoided, will result in death or serious injury.
 WARNING	Indicates a medium or low potential hazard which, if not avoided, could result in slight or moderate injury.
 CAUTION	Indicates a potential risk which, if not avoided, could result in property damage, data loss, reductions in performance, or unpredictable results.
 TIPS	Provides methods to help you solve a problem or save time.
 NOTE	Provides additional information as a supplement to the text.

Revision History

Version	Revision Content	Release Time
V1.0.1	Updated the introduction.	June 2023
V1.0.0	First release.	May 2023

Privacy Protection Notice

As the device user or data controller, you might collect the personal data of others such as their face, fingerprints, and license plate number. You need to be in compliance with your local privacy protection laws and regulations to protect the legitimate rights and interests of other people by implementing measures which include but are not limited: Providing clear and visible identification to inform people of the existence of the surveillance area and provide required contact information.

About the Manual

- The manual is for reference only. Slight differences might be found between the manual and the product.
- We are not liable for losses incurred due to operating the product in ways that are not in compliance with the manual.
- The manual will be updated according to the latest laws and regulations of related jurisdictions. For detailed information, see the paper user's manual, use our CD-ROM, scan the QR code or visit our official website. The manual is for reference only. Slight differences might be found between

the electronic version and the paper version.

- All designs and software are subject to change without prior written notice. Product updates might result in some differences appearing between the actual product and the manual. Please contact customer service for the latest program and supplementary documentation.
- There might be errors in the print or deviations in the description of the functions, operations and technical data. If there is any doubt or dispute, we reserve the right of final explanation.
- Upgrade the reader software or try other mainstream reader software if the manual (in PDF format) cannot be opened.
- All trademarks, registered trademarks and company names in the manual are properties of their respective owners.
- Please visit our website, contact the supplier or customer service if any problems occur while using the device.
- If there is any uncertainty or controversy, we reserve the right of final explanation.

Important Safeguards and Warnings

This section introduces content covering the proper handling of the whiteboard, hazard prevention, and prevention of property damage. Read carefully before using the whiteboard, and comply with the guidelines when using it.

Storage Requirements



- Stably put the whiteboard onto a support platform that is strong enough to prevent the whiteboard from falling.
- Do not place the whiteboard in a place exposed to sunlight or near heat sources.
- Store the whiteboard under allowed humidity (10%–90% (RH)) and temperature (–10 °C to +50 °C, or –14 °F to +122 °F) conditions.

Installation Requirements



- Do not install the whiteboard in a place exposed to sunlight or near heat sources.
- Keep the whiteboard away from dampness, dust, and soot.
- Install the whiteboard on a stable surface to prevent it from falling.
- Install the whiteboard in a well-ventilated place, and do not block its ventilation.
- The power supply must conform to the requirements of ES1 in IEC 62368-1 standard and be no higher than PS2. Please note that the power supply requirements are subject to the device label.
- The whiteboard is a class I electrical appliance. Make sure that the power supply of the whiteboard is connected to a power socket with protective earthing.
- The appliance coupler is a disconnection device. Keep it at a convenient angle when using it.
- Only applicable for use in altitudes below 5,000 meters.

Operation Requirements



- High voltage inside the whiteboard. Do not disassemble the whiteboard without a qualified professional present to avoid the risk of being exposed to danger.
- Improper use of the battery might result in a fire or explosion.
- Replace unwanted batteries with new batteries of the same type and model.
- Use the standard power adapter. We will assume no responsibility for any problems caused by the use of a nonstandard power adapter.
- Use the power cords that are recommended for the region and conform to the rated power specifications.
- Make sure all cables are connected correctly before plugging the whiteboard into the power. Do not overload the power socket or pull the power code. Otherwise, it might cause fire or electric shock.
- Do not ingest battery. Chemical Burn Hazard. This product contains a coin cell battery. If the coin cell battery is swallowed, it can cause severe internal burns in just 2 hours and can lead to death.

- Keep new and used batteries away from children. If the battery compartment does not close securely, stop using the product and keep it away from children.
- If you think batteries might have been swallowed or placed inside any part of the body, seek immediate medical attention.



- The whiteboard can run continuously for up to 16 hours each day. Please do not keep it running for longer than this time, otherwise the life of the screen will be affected.
- Do not drop or splash liquid onto the whiteboard, and make sure that there is no object filled with liquid on the whiteboard to prevent liquid from flowing into it.
- Operate the whiteboard within the rated range of power input and output.
- Do not disassemble the whiteboard without professional instruction.
- Use the whiteboard under allowed humidity (10%–90% (RH)) and temperature (0 °C to 40 °C, or 32 °F to 104 °F) conditions.
- The whiteboard is a class I electrical appliance. Make sure that the power supply of the whiteboard is connected to a power socket with protective earthing.
- The appliance coupler is a disconnection device. Keep it at a convenient angle when using it.

Maintenance Requirements



- Power off the whiteboard before maintenance. Do not use the liquid cleaner or spray cleaner when cleaning the whiteboard.
- Use the clean and soft cloth or use the special lens wiping cloth when cleaning the surface of display screen. Do not use the wet cloth to clean the display screen. Otherwise, it may do harm to the screen.

Table of Contents

Foreword	I
Important Safeguards and Warnings	III
1 Introduction	1
2 Packing List	2
3 Installation	3
3.1 Preparation	3
3.2 Installation Accessories	4
3.3 Installation Procedure	4
4 Appearance and Structure	9
4.1 Appearance	9
4.2 Ports	11
4.3 Buttons	13
5 Installing the Camera	15
Appendix 1 Touch Operation	16
Appendix 2 Cybersecurity Recommendations	17

1 Introduction

The smart interactive whiteboard is an integrated multimedia device, which integrates large HD screen, computer, electronic whiteboard, audio amplifier, application, and central control system. The whiteboard supports the following functions and features:

- 4K HD LCD display.
- Switch between Android and Windows systems (for Windows, you need to install a computer module).
- One-tap projection of devices such as mobile phones and tablets.
- Electronic whiteboard.
- Various software such as Microsoft Office and audio and video players.

2 Packing List

Check whether there is any obvious damage on the packing box. Unpack the box and check whether the components are complete according to the packing list.

Table 2-1 Packing list

Name	Quantity	Name	Quantity
Smart interactive whiteboard	1	Power cord	1
Stylus pen	2	HDMI cable	1
Wall mount bracket (installed on the whiteboard already)	1	Quick start guide	1
Accessory package	1	Remote control	1
Legal and Regulatory Information	1	—	—

3 Installation

3.1 Preparation

To ensure correct function and safety, remember to check whether your site is ready for the installation in the first place.

Table 3-1 Preparation

Item	Description
Grounding	<p>The IR touchscreen requires that the site should be safely grounded. Check the voltage between the live and neutral wires, between the live and ground wires, and between the neutral and ground wires. If the voltage is abnormal, report the issue to the technician.</p>  <p>The specific voltage requirements might vary depending on your local standard.</p>
Power supply	<p>The power supply circuit for the whiteboard should be independent from lighting and other circuits to avoid interference in power frequency.</p>
Wall	<p>Make sure that the wall can bear a load of 160 kg or more.</p>
Space	<p>Make sure that there is enough space for the whiteboard. The ideal reserved space is 10 mm greater than the length and height of the whiteboard.</p>
Tools	<p>Prepare the installation tools.</p> <ul style="list-style-type: none"> ● To install the whiteboard onto a brick or concrete wall, you need an electric hammer, impact driver, iron hammer, open-ended spanner, laser level or spirit level, crosshead screwdriver, work gloves, and other tools. ● To install the whiteboard onto a wooden wall, you need an iron hammer, self-tapping screws, laser level or spirit level, crosshead screwdriver, work gloves, and other tools.

3.2 Installation Accessories

Figure 3-1 Installation accessories

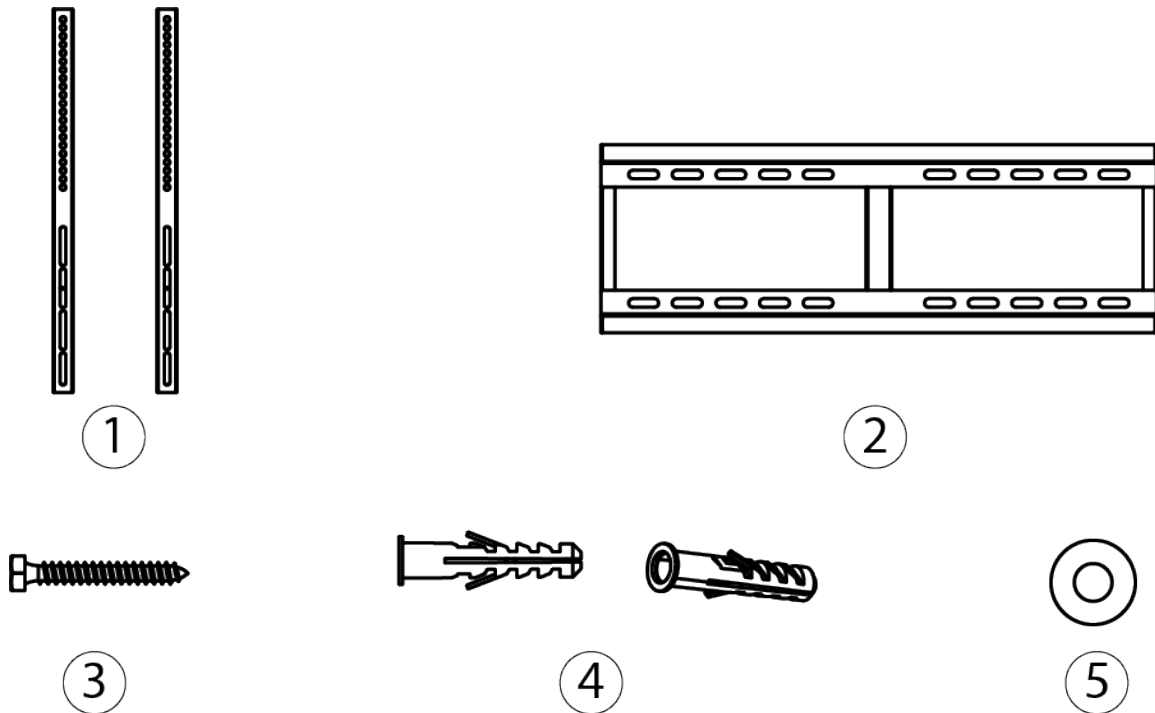

Table 3-2 Accessory description

No.	Name	Quantity
1	Vertical bracket	2
2	Horizontal bracket	1
3	ø6 × 50 wall-mount screw	8
4	Plastic expansion plug for screw	8
5	Gasket	8

3.3 Installation Procedure

Procedure

Step 1 Insert M5 × 100 screws 2–10 mm into the vertical brackets.



The M5 × 100 screws are already installed on the whiteboard.

Figure 3-2 Insert screws into vertical brackets

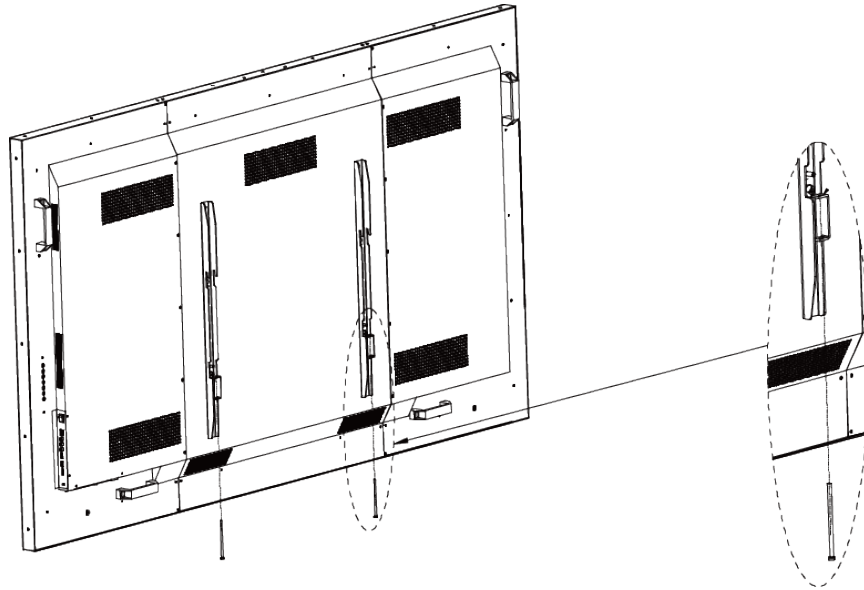

Step 2 Mark screw locations on the wall and then drill holes.

- 1) Identify a suitable installation position, and then mark the screw locations.



The recommended distance between the bottom of the whiteboard and the ground is 80–85 cm.

Figure 3-3 Installation dimensions (mm [inch])

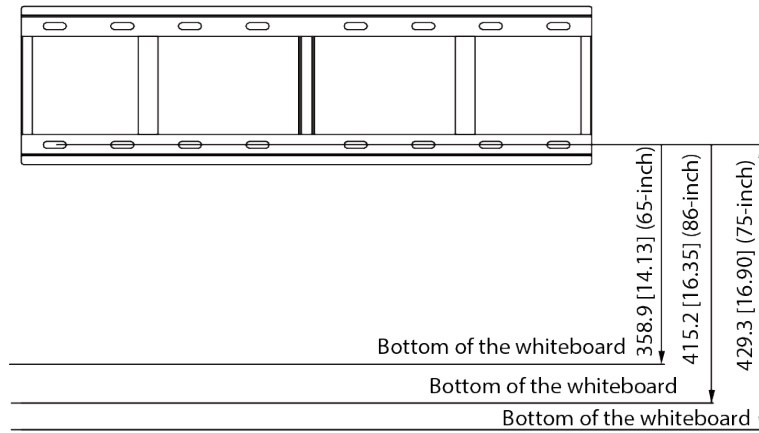

- 2) Drill holes at the marked locations.

Figure 3-4 Required hole diameter and depth (mm [inch])

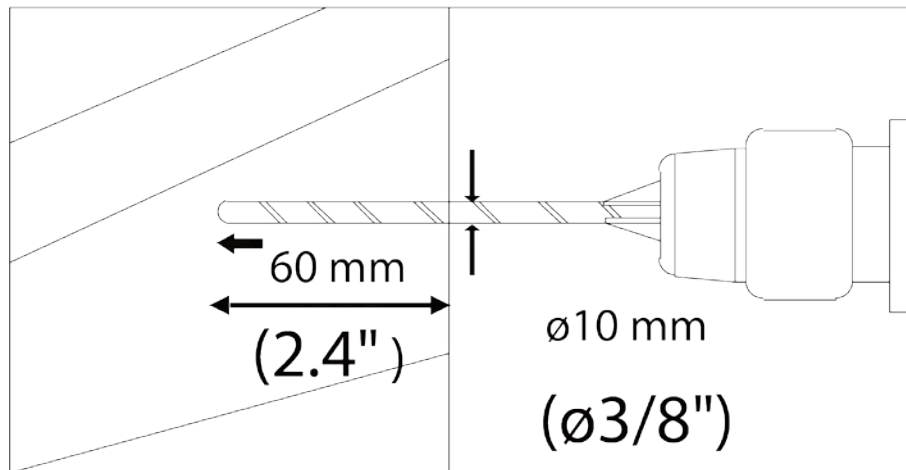

Step 3 Use 6 × 50 mm wall-mount screws to attach the horizontal bracket onto the wall and keep it horizontal.

Figure 3-5 Install the horizontal bracket

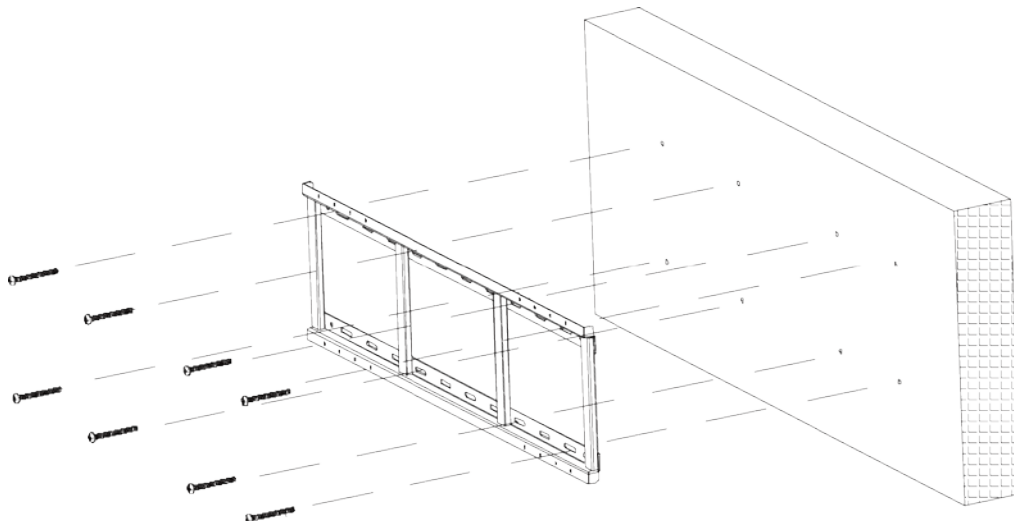

Step 4 Attach the vertical brackets onto the wall. You can use the holes on the vertical brackets to adjust the height of the whiteboard.

- For 65-inch series, you can use the first to the third hole from up to down, with the maximum adjustment range of 30 mm.
- For 75/86-inch series, you can use the first to the seventh hole from up to down, with the maximum adjustment range of 90 mm.

Figure 3-6 Attach the vertical brackets (65-inch series) (mm [inch])

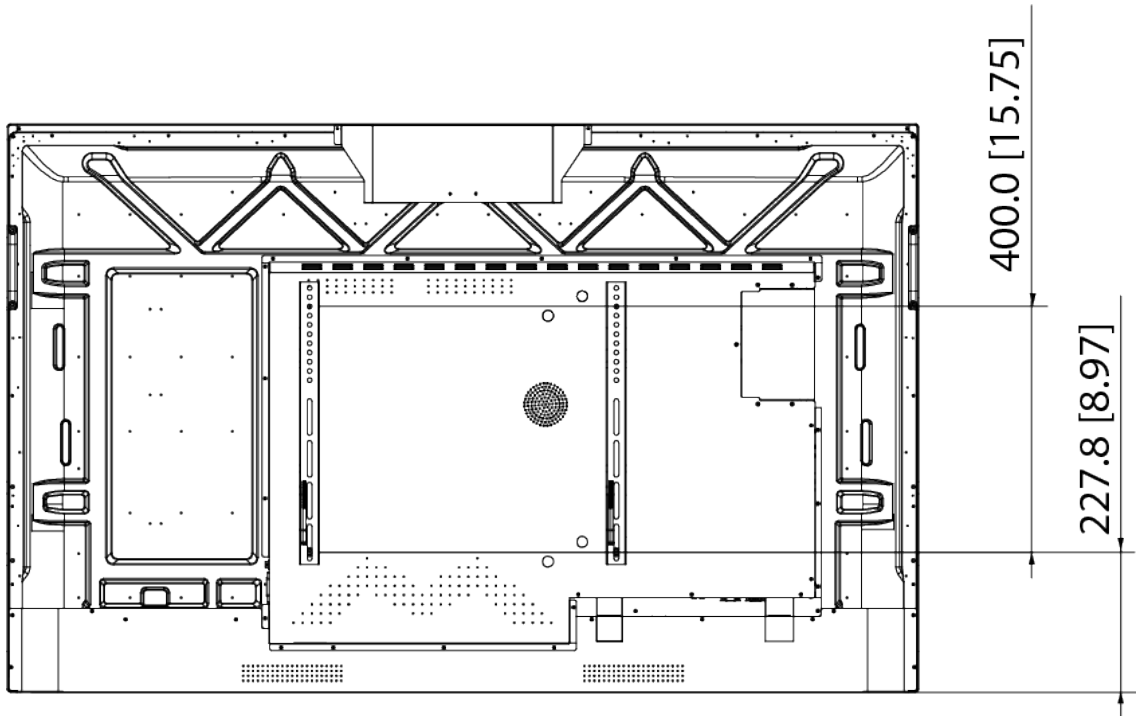

Figure 3-7 Attach the vertical brackets (75-inch series) (mm [inch])

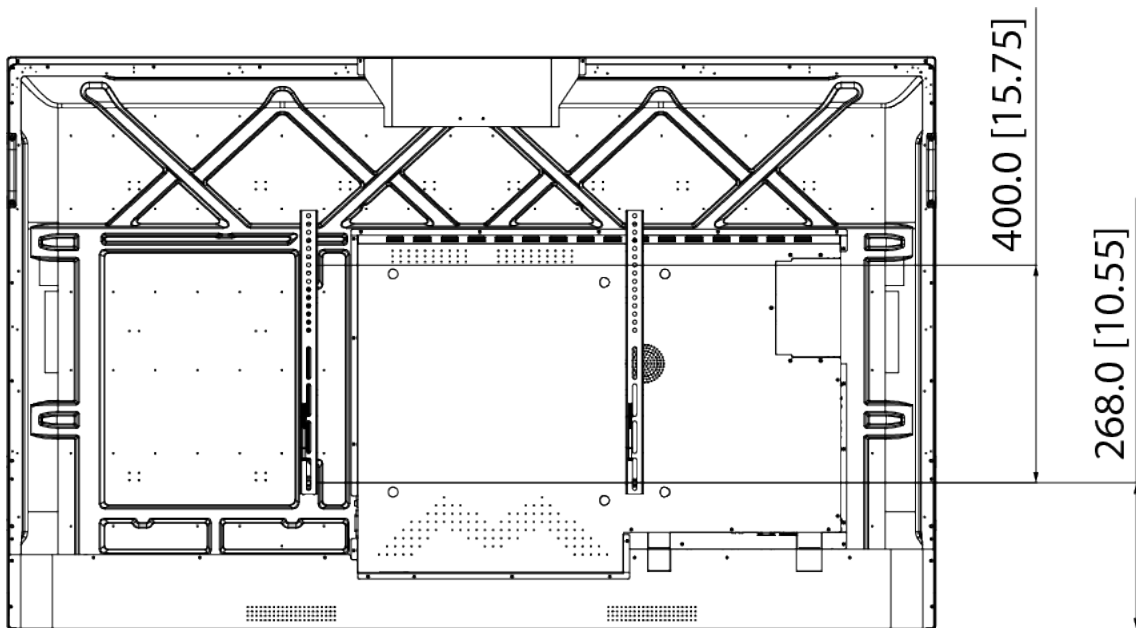
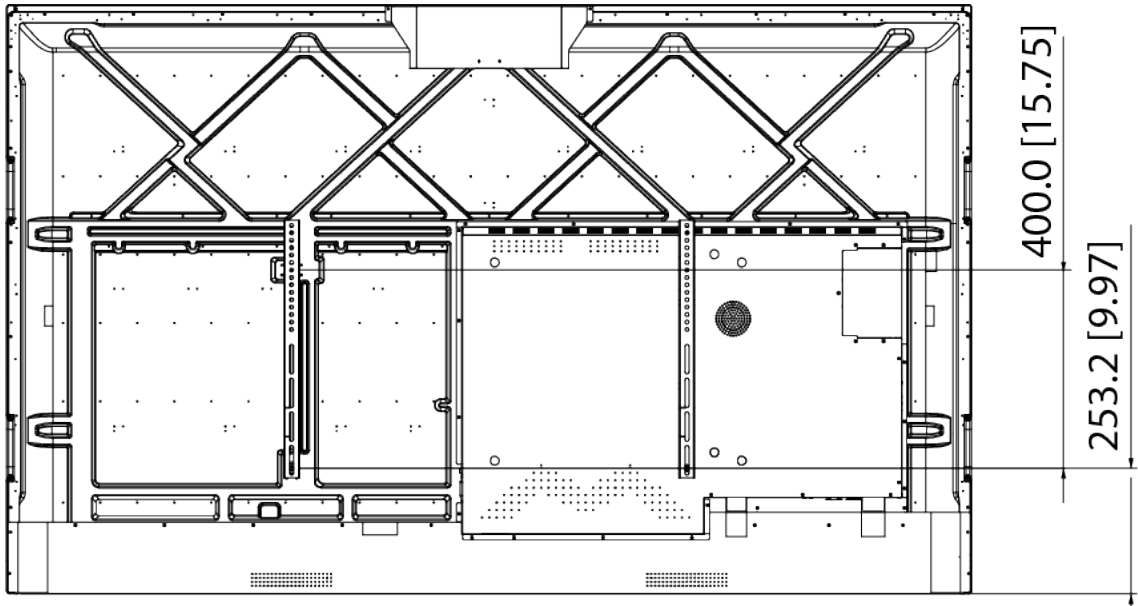

Figure 3-8 Attach the vertical brackets (86-inch series) (mm [inch])



Step 5 Tighten the screws at the bottom of the vertical brackets to secure the brackets.



Make sure to use the appropriate screwdriver.

Figure 3-9 Secure the vertical brackets

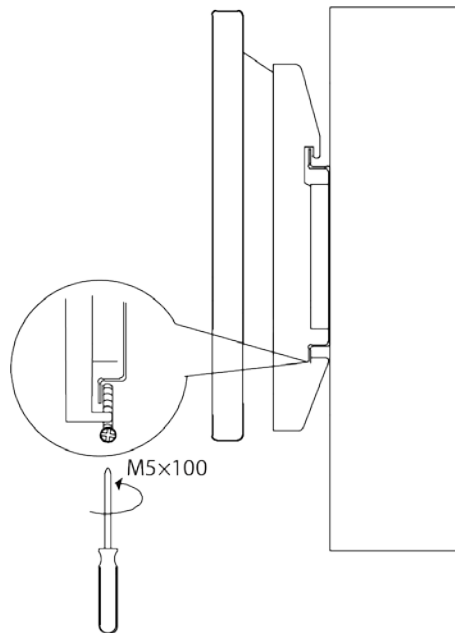

4 Appearance and Structure

4.1 Appearance

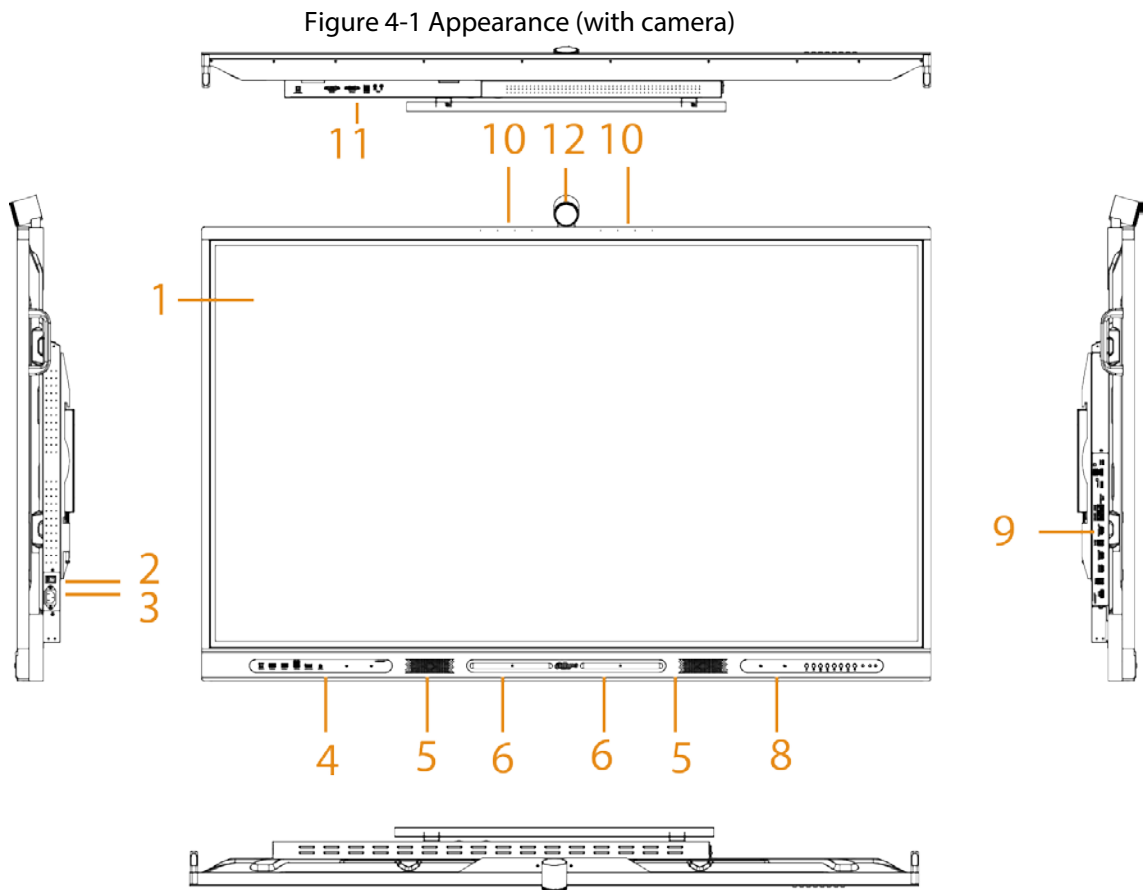

Figure 4-2 Appearance (without camera)

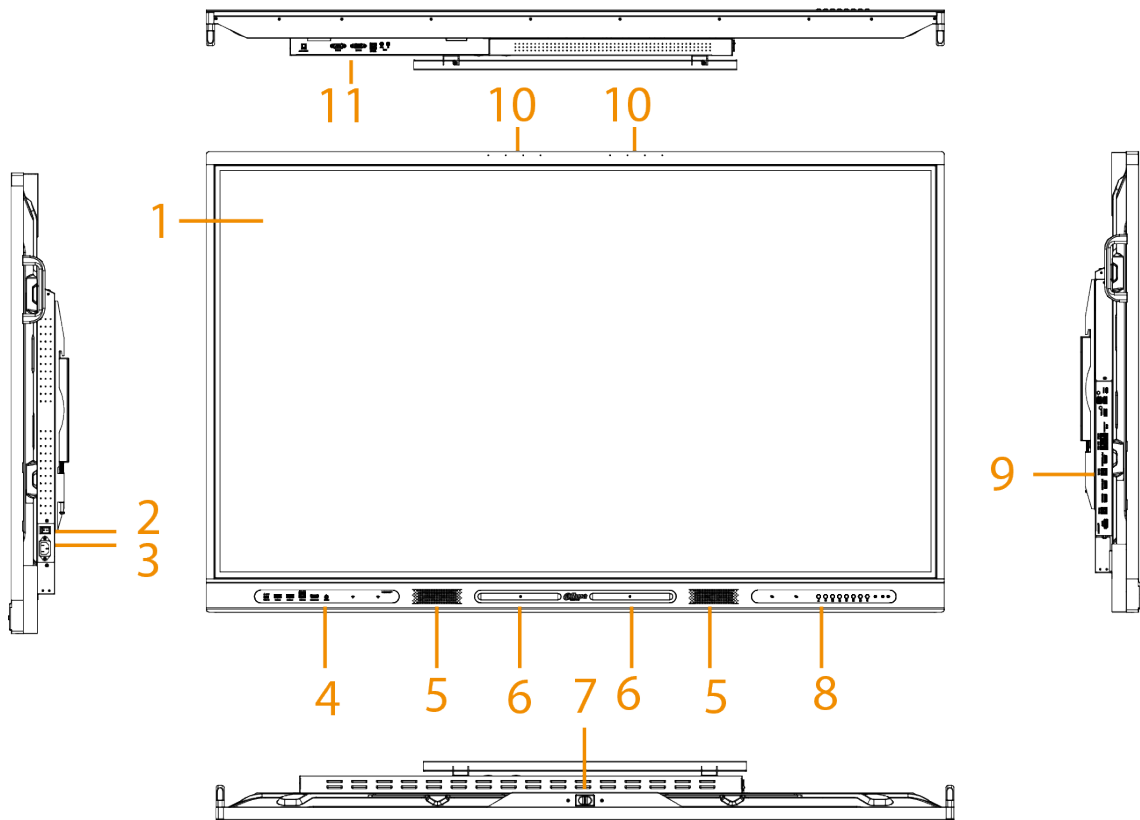



Table 4-1 Appearance description

No.	Description
1	LCD.
2	Power switch. Turn on or turn off the power supply of the whiteboard.
3	Power input port. Inputs 100–240 VAC power.  After connecting to power supply, press the rocker switch to turn on the whiteboard.
4	Ports on the front panel. For details, see Table 4-2.
5	Speaker holes.
6	Magnetic stylus pen attach area.
7	USB port for camera installation. For details about how to install the camera ,see "5 Installing the Camera".
8	Buttons on the front panel. For details, see Table 4-5.
9	Ports on the side of the rear panel. For details, see Table 4-3.
10	Microphones. Pick up live audio.
11	Ports on the bottom of the rear panel. For details, see Table 4-4.
12	Camera.  You need to purchase the camera separately.

4.2 Ports

Figure 4-3 Ports on the front panel

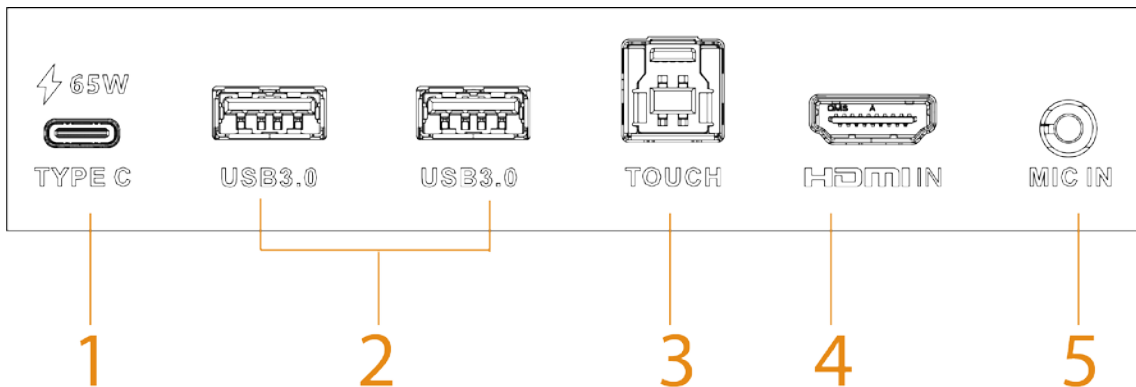

Table 4-2 Front panel ports

No.	Port	Description
1	Type C	Multi-function Type C port. It can be used for signal input and touch control.
2	USB 3.0	Connects to USB devices such as mobile hard disk, USB flash drive, USB keyboard, USB mouse. It is applicable to Android system and computer module. After you connect the whiteboard with your computer through the TYPE C, HDMI IN port and TOUCH port on the front panel, insert a USB device to the USB 3.0 port and then the USB device will be read and found on your computer.
3	TOUCH	Transmits touch signals. The port only works with the HDMI IN port next to it. After you connect your computer with the HDMI IN port, connect the TOUCH port to the USB port of the computer and then you can control the computer through touch operations on the whiteboard.
4	HDMI IN	Inputs uncompressed HD video signals and multichannel audio signals from the external HDMI signal source.
5	MIC IN	Audio input port.

Figure 4-4 Ports on the side of the rear panel

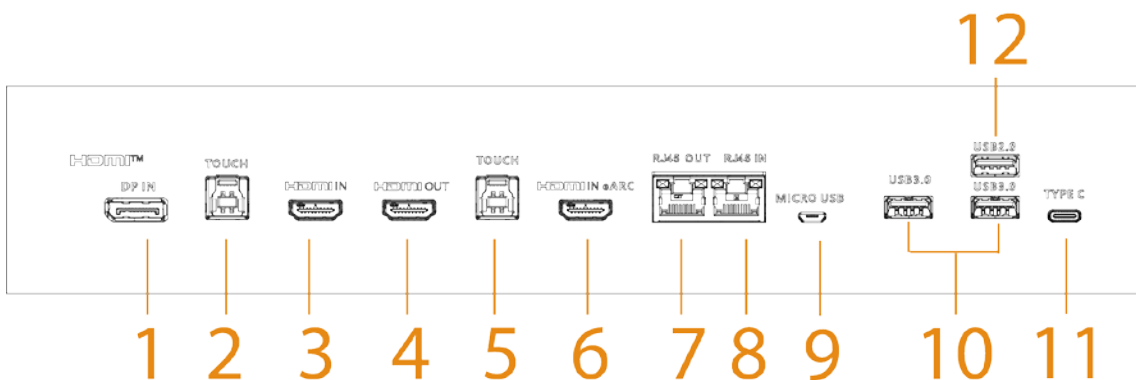

Table 4-3 Description of ports on the side of the rear panel

No.	Port	Description
1	DP IN	HD digital signal input port, which can be connected to computer and family theater.
2	TOUCH	Transmits touch signals. The port only works with the HDMI IN or DP IN port next to it. After you connect your computer with the whiteboard through the HDMI IN or DP IN port, connect the TOUCH port to the USB port of the computer and then you can control the computer through touch operations on the whiteboard.
3	HDMI IN	Inputs uncompressed HD video signals and multichannel audio signals from the external HDMI signal source.
4	HDMI OUT	HD audio and video signal output port. Transmits uncompressed HD video and multichannel audio data.
5	TOUCH	Transmits touch signals. The port only works with the HDMI IN eARC or HDMI IN (R) port next to it. After you connect your computer with the whiteboard through the HDMI IN eARC or HDMI IN (R) port, connect the TOUCH port to the USB port of the computer and then you can control the computer through touch operations on the whiteboard.
6	HDMI IN eARC	HDMI input port that supports enhanced audio return channel (eARC). Inputs video and audio signals from the external HDMI signal source.  To use the eARC function, you need to connect to devices that supports eARC.
7	RJ-45 OUT	Network output port. Connects to other devices so that the whiteboard can share network like a router.
8	RJ-45 IN	Network input port. Connects to the network cable to access network.
9	Micro USB	Only applicable to Android system. Uses for system debugging.
10	USB 3.0	Connects to USB devices such as mobile hard disk, USB flash drive, USB keyboard, and USB mouse. It is applicable to Android system and computer module.
11	Type C	Multi-function Type C port. It can be used for signal input, and touch control.
12	USB 2.0	Connects to USB devices such as mobile hard disk, USB flash drive, USB keyboard, and USB mouse. Only available for Android system.

Figure 4-5 Ports on the bottom of the rear panel

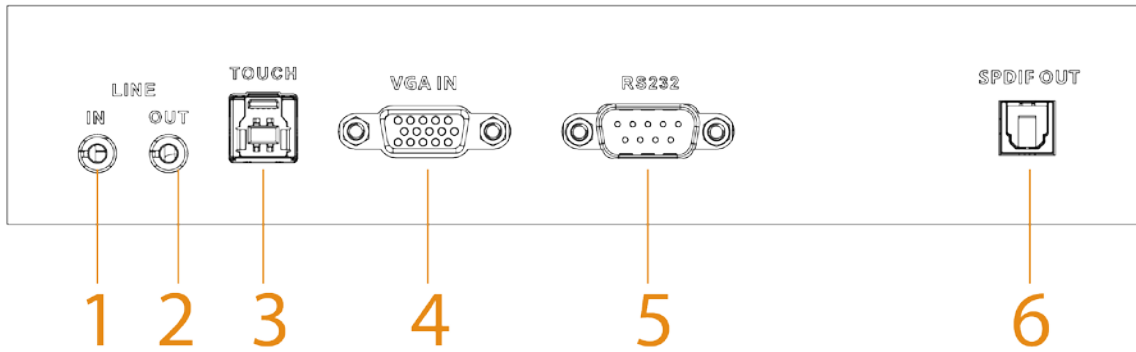

Table 4-4 Description of ports on the bottom of the rear panel

No.	Port	Description
1	LINE IN	Line input port. Works with VGA IN port.
2	LINE OUT	Line output port. Connects to earphones or speakers.
3	TOUCH	Transmits touch signals. The port only works with the VGA IN port next to it. After you connect your computer with the whiteboard through the VGA IN port, connect the TOUCH port to the USB port of the computer and then you can control the computer through touch operations on the whiteboard.
4	VGA IN	Video input port. Connects to computers, set-top boxes, and other video devices with VGA output ports.
5	RS-232	Transmits data between devices. Connect to central control devices with RS-232 port.
6	SPDIF OUT	Sony/Philips Digital Interface. Outputs audio to earphones or speakers.







4.3 Buttons

Figure 4-6 Buttons



Table 4-5 Description of buttons

Button	Description
	Enter comment mode.
	Adjust volume.
	Enter curtain mode.

Button	Description
	Press the button to enable the touch lock.  When the touch lock is enabled, the touchscreen is not available. Press the power button 3 times to unlock the touch lock.
	Select signal sources.
	Open or close the navigation bar.
	Go back to the home screen.
	Power button. Turn on or turn off the screen.

5 Installing the Camera

Figure 5-1 Install the Camera

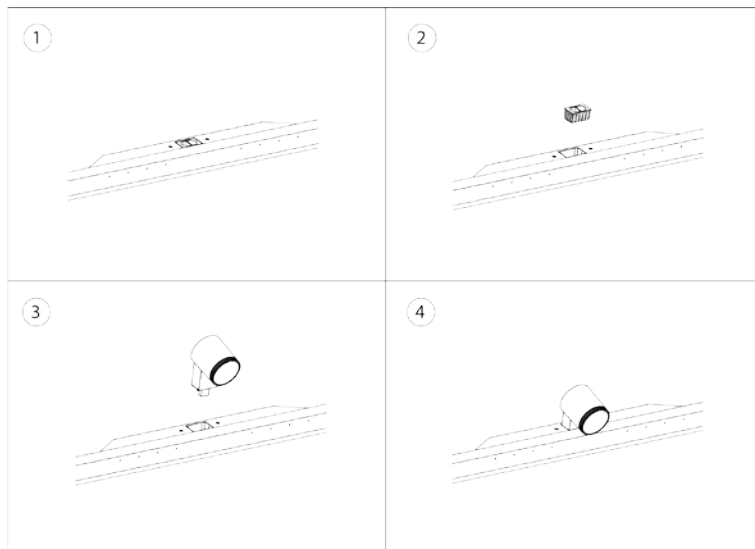

Appendix 1 Touch Operation

You can use the stylus pen or directly use your fingers to operate the device screen.



This section uses operation with stylus pen as an example.

Appendix Table 1-1 Touch operations

Operation	Description
Tap	Tap the screen once with the stylus pen.
Double-tap	Tap the screen twice with the stylus pen (The time gap between the taps is around 0.5 s).
Context menu	Slightly touch the screen for 1 to 2 seconds with the stylus pen. Lift the stylus pen when there is a circle on the screen, and then the context menu is displayed.
Drag	Hold the icon that needs to be dragged with the stylus pen and then move the stylus pen to the target place. Lift the stylus pen to drop the item.
Slide	Hold the screen (such as the slider that is used for the web browser) that you want to slide with the stylus pen, and then slide the stylus pen toward the direction you want. Lift the stylus pen to release the screen.
Zoom	Use the stylus pen to press and hold the window (such as the web pages and images), and then use another stylus pen to drag the window to zoom in and zoom out.

Appendix 2 Cybersecurity Recommendations

Cybersecurity is more than just a buzzword: it's something that pertains to every device that is connected to the internet. IP video surveillance is not immune to cyber risks, but taking basic steps toward protecting and strengthening networks and networked appliances will make them less susceptible to attacks. Below are some tips and recommendations from Dahua on how to create a more secured security system.

Mandatory actions to be taken for basic device network security:

1. Use Strong Passwords

Please refer to the following suggestions to set passwords:

- The length should not be less than 8 characters.
- Include at least two types of characters; character types include upper and lower case letters, numbers and symbols.
- Do not contain the account name or the account name in reverse order.
- Do not use continuous characters, such as 123, abc, etc.
- Do not use overlapped characters, such as 111, aaa, etc.

2. Update Firmware and Client Software in Time

- According to the standard procedure in Tech-industry, we recommend to keep your device (such as NVR, DVR, IP camera, etc.) firmware up-to-date to ensure the system is equipped with the latest security patches and fixes. When the device is connected to the public network, it is recommended to enable the "auto-check for updates" function to obtain timely information of firmware updates released by the manufacturer.
- We suggest that you download and use the latest version of client software.

"Nice to have" recommendations to improve your device network security:

1. Physical Protection

We suggest that you perform physical protection to device, especially storage devices. For example, place the device in a special computer room and cabinet, and implement well-done access control permission and key management to prevent unauthorized personnel from carrying out physical contacts such as damaging hardware, unauthorized connection of removable device (such as USB flash disk, serial port), etc.

2. Change Passwords Regularly

We suggest that you change passwords regularly to reduce the risk of being guessed or cracked.

3. Set and Update Passwords Reset Information Timely

The device supports password reset function. Please set up related information for password reset in time, including the end user's mailbox and password protection questions. If the information changes, please modify it in time. When setting password protection questions, it is suggested not to use those that can be easily guessed.

4. Enable Account Lock

The account lock feature is enabled by default, and we recommend you to keep it on to guarantee the account security. If an attacker attempts to log in with the wrong password several times, the corresponding account and the source IP address will be locked.

5. Change Default HTTP and Other Service Ports

We suggest you to change default HTTP and other service ports into any set of numbers between

1024–65535, reducing the risk of outsiders being able to guess which ports you are using.

6. **Enable HTTPS**

We suggest you to enable HTTPS, so that you visit Web service through a secure communication channel.

7. **MAC Address Binding**

We recommend you to bind the IP and MAC address of the gateway to the device, thus reducing the risk of ARP spoofing.

8. **Assign Accounts and Privileges Reasonably**

According to business and management requirements, reasonably add users and assign a minimum set of permissions to them.

9. **Disable Unnecessary Services and Choose Secure Modes**

If not needed, it is recommended to turn off some services such as SNMP, SMTP, UPnP, etc., to reduce risks.

If necessary, it is highly recommended that you use safe modes, including but not limited to the following services:

- SNMP: Choose SNMP v3, and set up strong encryption passwords and authentication passwords.
- SMTP: Choose TLS to access mailbox server.
- FTP: Choose SFTP, and set up strong passwords.
- AP hotspot: Choose WPA2-PSK encryption mode, and set up strong passwords.

10. **Audio and Video Encrypted Transmission**

If your audio and video data contents are very important or sensitive, we recommend that you use encrypted transmission function, to reduce the risk of audio and video data being stolen during transmission.

Reminder: encrypted transmission will cause some loss in transmission efficiency.

11. **Secure Auditing**

- Check online users: we suggest that you check online users regularly to see if the device is logged in without authorization.
- Check device log: By viewing the logs, you can know the IP addresses that were used to log in to your devices and their key operations.

12. **Network Log**

Due to the limited storage capacity of the device, the stored log is limited. If you need to save the log for a long time, it is recommended that you enable the network log function to ensure that the critical logs are synchronized to the network log server for tracing.

13. **Construct a Safe Network Environment**

In order to better ensure the safety of device and reduce potential cyber risks, we recommend:

- Disable the port mapping function of the router to avoid direct access to the intranet devices from external network.
- The network should be partitioned and isolated according to the actual network needs. If there are no communication requirements between two sub networks, it is suggested to use VLAN, network GAP and other technologies to partition the network, so as to achieve the network isolation effect.
- Establish the 802.1x access authentication system to reduce the risk of unauthorized access to private networks.
- Enable IP/MAC address filtering function to limit the range of hosts allowed to access the

device.

More information

Please visit Dahua official website security emergency response center for security announcements and the latest security recommendations.

ENABLING A SAFER SOCIETY AND SMARTER LIVING

ZHEJIANG DAHUA VISION TECHNOLOGY CO., LTD.

Address: No. 1399, Binxing Road, Binjiang District, Hangzhou, P. R. China | Website: www.dahuasecurity.com | Postcode: 310053

Email: dhoverseas@dhvisiontech.com | Tel: +86-571-87688888 28933188